

DO NOT SCALE FROM THIS PRINT

# IPT1-1XX-XX-XX-D-VS-XX-XXX

No OF POS PER ROW  
-02 THRU -25

LEAD STYLE  
-01

PLATING SPECIFICATION

-S: HEAVY SELECTIVE GOLD (USE T-1S6-25-S-2)  
-SM: HEAVY SELECTIVE GOLD, MATTE TIN ON TAIL (USE T-1S6-25-SM-2)

OPTION

-POL: POSITION #1 REMOVED (USE IPT1-XX-D-P)  
-K: POLYAMIDE FILM PAD [AVAILABLE ON POSITIONS -03 THRU -25 ONLY]  
-FL: FRICTION LOCK [POS -05 THRU -25] (USE IPT1-XX-D-FL-X & T-1S64-05-X)  
-TR: TAPE AND REEL

OPTION

-A: ALIGNMENT PIN (USE SM-A11) [4 POS MIN]  
-LC: LOCKING CLIP (USE LC-07-TM) [4 POS MIN]

TAIL OPTION

-VS: VERTICAL SURFACE MOUNT

ROW SPECIFICATION

-D: DOUBLE (USE IPT1-XX-D)

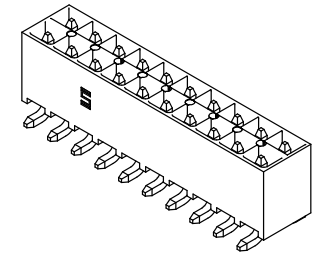
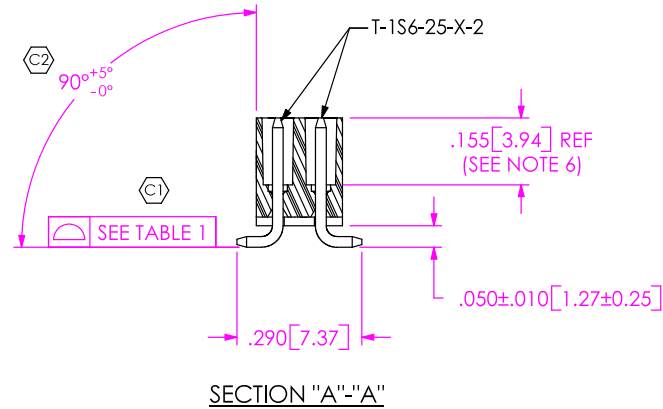
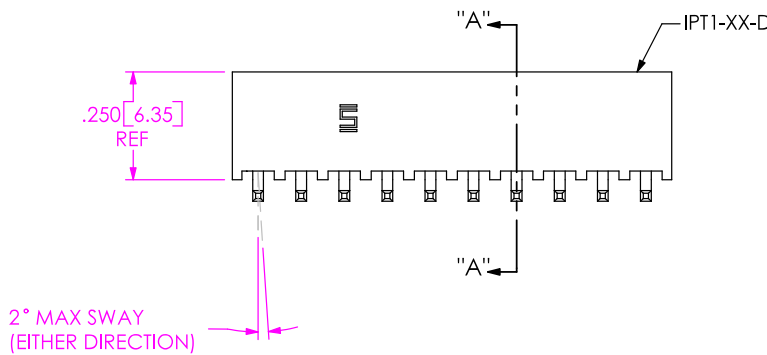
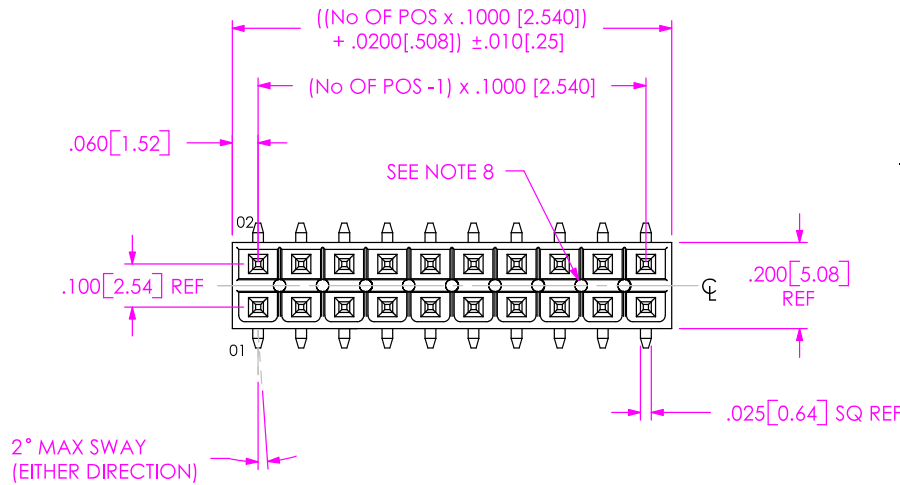

PACKAGING VIEW

[-02 POSITION TO BE BULK PACKAGED]

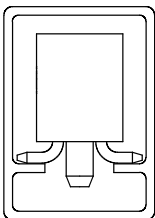

TUBE: PT-1-24-01-103  
PLUG: TP-09

IN-PROCESS

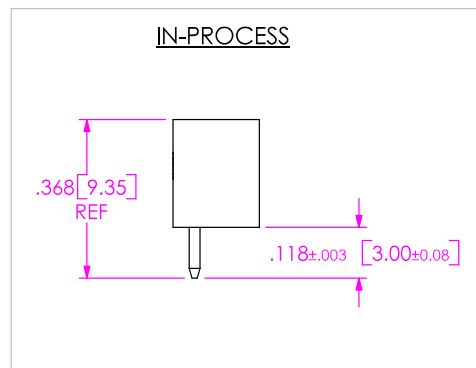

TABLE 1

POSITION	COPLANARITY
-02 THRU -10	.005 [.13]
-11 THRU -25	.006 [.15]

NOTES:

- ⊕ REPRESENTS A CRITICAL DIMENSION.
- MAXIMUM ALLOWABLE CUT FLASH: .010 [.25].
- MINIMUM TERMINAL PUSH OUT FORCE: 2 lbs.
- MAXIMUM VARIATION BETWEEN PIN ROWS: .005 [.13].
- "END WALLS" AFTER CUTTING SHOULD BE .015+/- .003 [.38+/- .08].
- PINS TO BE FLUSH TO .008 [.20] MAXIMUM RECESSED IN BODY.
- ALL DIMENSIONS TO BE ABOUT CENTERLINE WITHIN +/- .005 [.13].
- PRESENCE OF VOIDS IS OPTIONAL AND PATTERN TO WHICH THEY OCCUR IS VARIABLE.

UNLESS OTHERWISE SPECIFIED, DIMENSIONS ARE IN INCHES.

TOLERANCES ARE:  
DECIMALS: .XX:  $\pm .01$  [.3]  
.XXX:  $\pm .005$  [.13]  
.XXXX:  $\pm .0020$  [.051]

PROPRIETARY NOTE

THIS DOCUMENT CONTAINS INFORMATION CONFIDENTIAL AND PROPRIETARY TO SAMTEC, INC. AND SHALL NOT BE REPRODUCED OR TRANSFERRED TO OTHER DOCUMENTS OR DISCLOSED TO OTHERS OR USED FOR ANY PURPOSE OTHER THAN THAT WHICH IT WAS OBTAINED WITHOUT THE EXPRESSED WRITTEN CONSENT OF SAMTEC, INC.

**SAMTEC**

520 PARK EAST BLVD. NEW ALBANY, IN 47150  
\* PHONE: 812.944.6733 FAX: 812.948.5047  
e-Mail: [INFO@SAMTEC.COM](mailto:INFO@SAMTEC.COM) CODE: 55322

MATERIAL: DO NOT SCALE DRAWING  
INSULATOR: VECTRA E130i, COLOR: BLACK  
CONTACT: PHOS BRONZE, 510, 3/4 HARD

SHEET SCALE: 2.25:1

DESCRIPTION:  
.100 DOUBLE ROW SHROUDED TERMINAL ASSEMBLY

DWG. NO.:  
IPT1-1XX-XX-XX-D-VS-XX-XXX

BY: DEAN P 11-06-2002 SHEET 1 OF 2

**-FL: FRICTION LOCK OPTION**  
IPT1-110-01-X-D-VS-FL SHOWN

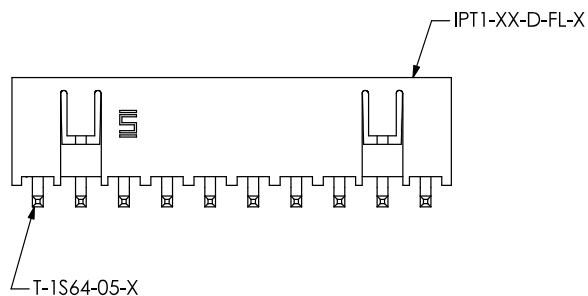

**-A: ALIGNMENT PIN OPTION**  
IPT1-110-01-X-D-VS-A SHOWN

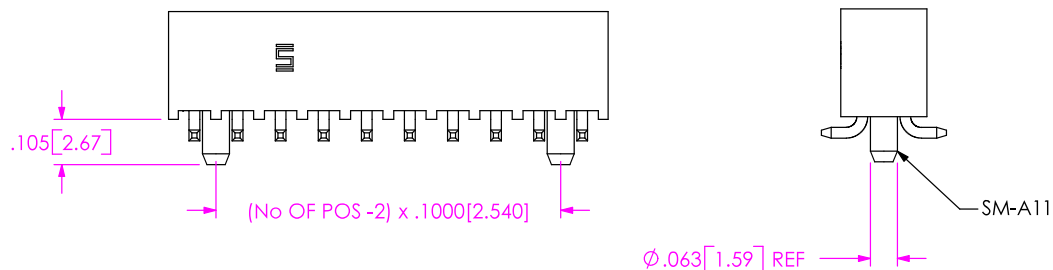

**-POL: POLARIZED OPTION**  
IPT1-110-01-X-D-VS-POL SHOWN

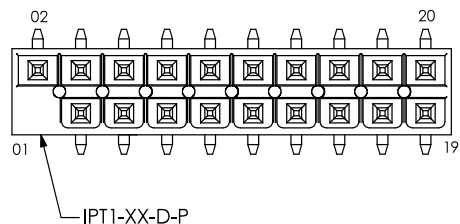

**-K: POLYAMIDE FILM PAD OPTION**  
[AVAILABLE ON POSITIONS -03 THRU -25 ONLY]

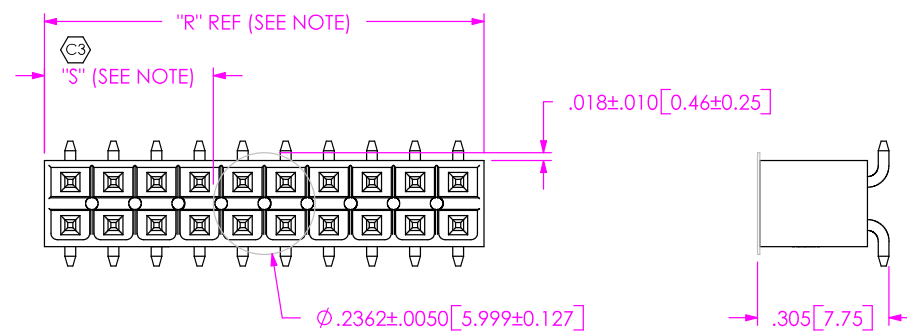

**-LC: LOCKING CLIP OPTION**  
IPT1-110-01-X-D-VS-LC-FL SHOWN

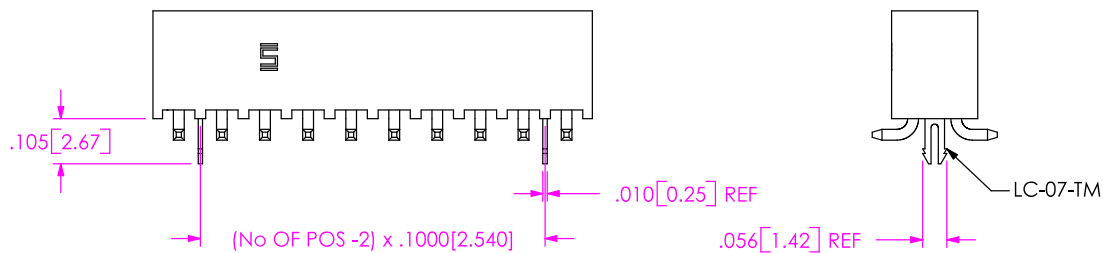

NOTE: "R" = USE MEASURED DIMENSION  
"S" = (( "R" - .2362 [6.000] ) / 2 ) ±.020 [51]

**PROPRIETARY NOTE**  
THIS DOCUMENT CONTAINS INFORMATION CONFIDENTIAL AND PROPRIETARY TO SAMTEC, INC. AND SHALL NOT BE REPRODUCED OR TRANSFERRED TO OTHER DOCUMENTS OR DISCLOSED TO OTHERS OR USED FOR ANY PURPOSE OTHER THAN THAT WHICH IT WAS OBTAINED WITHOUT THE EXPRESSED WRITTEN CONSENT OF SAMTEC, INC.

DO NOT SCALE DRAWING  
SHEET SCALE: 2:25:1

**SAMTEC**

520 PARK EAST BLVD, NEW ALBANY, IN 47150  
\* PHONE: 812.944.6733 FAX: 812.948.5047  
e-Mail: [INFO@SAMTEC.COM](mailto:INFO@SAMTEC.COM) CODE: 55322

DESCRIPTION:  
.100 DOUBLE ROW SHROUDED TERMINAL ASSEMBLY

DWG. NO.  
IPT1-1XX-XX-XX-D-VS-XX-XXX

BY: DEAN P 11-06-2002 SHEET 2 OF 2